

PRODUCT INFORMATION

- Elegant and trendy channel rod system;
- Easy and quick to assemble;
- Available colours: Bronze, Inox, Antique Bronze, Gold, Chrome and Black;
- CRS and MRS components can be used as well;
- Both short and long pulley end caps are available;
- Decorative finials can be fitted on the long pulley end caps;
- Rod size: Standard 5,80 meter, Chrome: 5,00 meter;
- Rail quality: aluminium, chromated, with an anodized finish or chrome layer finish

RAIL SPECIFICATIONS

- Scale 1:1
- Weight: 460 grammes per meter
- Aluminium extrusion
- Dimension: 28 mm

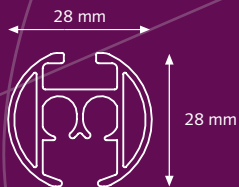

FOR USE IN

Domestic and / or contract market, or at any location where a high quality, elegant and corded operated channel rod system is required.

- ① CRS Corded End Cap Short
- ② MRS Channel Rod
- ③ Traverse Cord
- ④ CS/CCS/FMS Carrier
- ⑤ Plastic Master Carrier Overlap
- ⑥ Plastic Master Carrier Underlap
- ⑦ CCS Cord Connector
- ⑧ Easyfold Easy-Snap Carriers
- ⑨ CRS Corded End Pulley Base

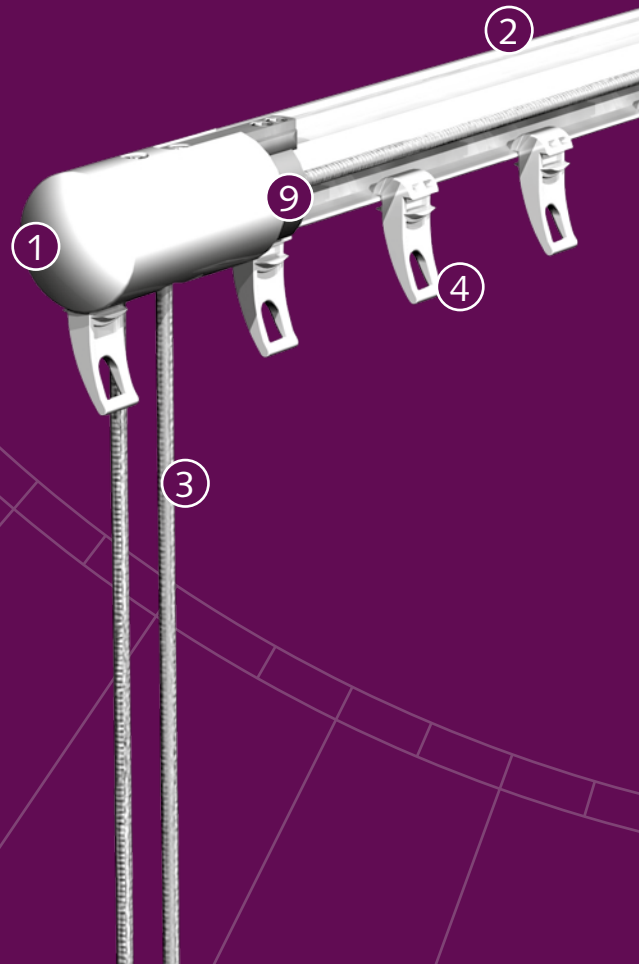

APPLICATIONS

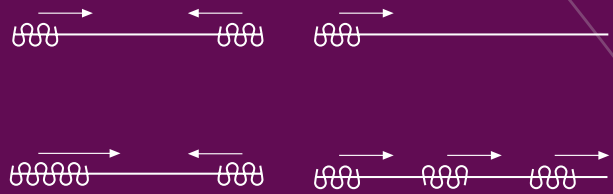



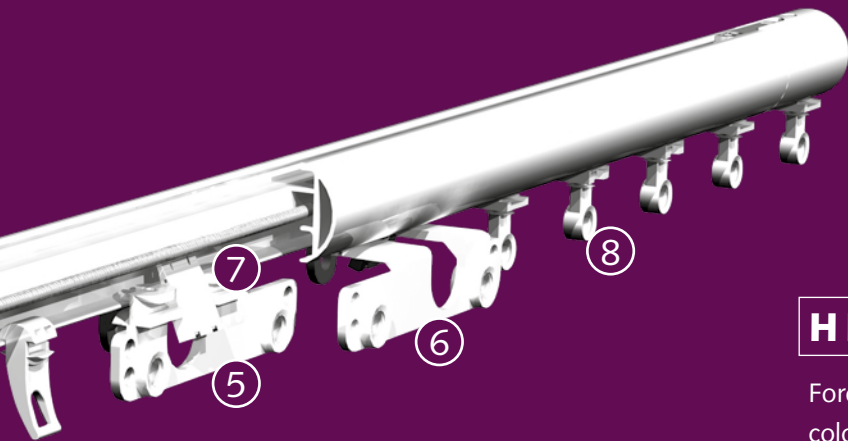



Cross-Section Channel Rod with cord connectors and carriers.

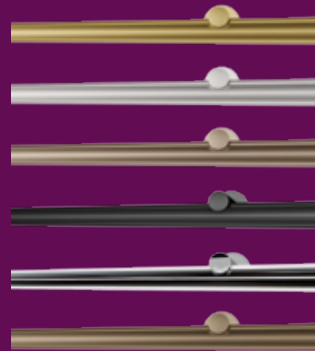

HIGH GRADE ALUMINIUM

Forest offers the 28 mm Channel Rod in the following colours:



-  Gold
-  Inox
-  Bronze
-  Black
-  Chrome
-  Antique Bronze

MOUNTING BRACKETS

CRS Ceiling Bracket



CRS Ceiling Support 4 cm or 10 cm.

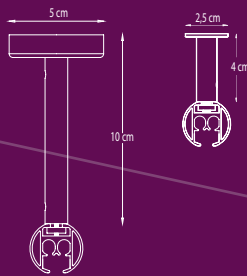

CRS Wall Bracket Single

8 cm, 12 cm and 16 cm
(Base plate for the 12 cm and 16 cm bracket is 6,2 cm, similar to the double wall brackets.)

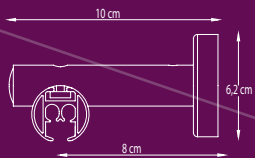

CRS Wall Bracket

Double

16 cm

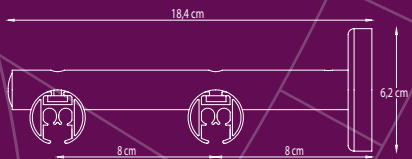

CRS Wall Bracket

Double

16 cm Ø 20/28 mm









Available colours:

01 White, 02 Gold, 03 Inox, 04 Bronze, 06 Black,
07 Chrome and 09 Antique Bronze

*Inox coloured components can be used for both the inox
and bronze coloured channel rod.*

CRS CHANNEL ROD

	Gold	5,80 mtr	5701282580
	Inox	5,80 mtr	5701283580
	Bronze	5,80 mtr	5701284580
	Black	5,80 mtr	5701286520
	Chrome	5,00 mtr	5701287525
	Antique Bronze	5,80 mtr	5701289580

CRS CORDED END CAP SHORT

Length of End Cap 53 mm
Including End Pulley Base

61302..001
2/box

Colours: 02, 03, 04 and 09

CRS WALL BRACKET

Length Single: 8 cm 582008..28
Length Single: 12 cm 582012..28
Length Single: 16 cm 582016..28

Length Double: 16 cm
Ø 28 mm 582216..28
Ø 20/28 mm 5822..2028

Colours: 02, 03 and 09 2/box

MRS WALL BRACKET SINGLE



Length: 12 cm

57200..120
2/box

Colours: 06 and 07

MASTER CARRIER UNDERLAP



PLASTIC

Colours: 01, 03 and 06

4815201010
25/box

transparent

4815101000

CRS CEILING BRACKET



Aluminium

5818003000
100/box

CS/CCS/FMS GLIJDER



10 carriers per strip

25101..000
250/box

Colours: 01, 03 and 06

CRS CEILING BRACKET WITH HOLE



Silver

5818003103
100/box

CCS CORD CONNECTOR



Connects cord to the master carrier

3030301000
100/box

MRS CEILING BRACKET SMALL



Length: 1,5 cm

57184..050
4/box

Colours: 06 and 07

TRAVERSE CORD



Nylon drapery cord designed for strong smooth slide, ø 3.5 mm, White

1030401000
250 mtr/roll

MRS CEILING BRACKET



Length: 5 cm

57180..050
4/box

Colours: 06 and 07

TENSION PULLEY



PVC, White

1030501000
25/box

CRS CEILING SUSPENSION BRACKET



Length: 10 cm

58180.2028
2/box

Colours: 02, 03 and 09

CORD WEIGHT



PVC, White

3030601000
20/box

CRS CEILING SUSPENSION BRACKET



Length: 4 cm

58181.2000
2/box

Colours: 02, 03 and 09

ELECTRIC POWERED RAILCUTTER



Cutting Tool for all light aluminium profiles.

1061100000
1/Each

Replacement Blade

For Electric Powered Railcutter

1061200000
1/Each

MASTER CARRIER OVERLAP STRAIGHT



PLASTIC

Colours: 01, 03 and 06

4815101010
25/box

transparent

4815201000

DISTRIBUTOR:

FOREST
DRAPERY HARDWARE



Download Forest brochures

CRS Corded-CB-11-2015